

MANUAL

ABOVE GROUND FUEL TANKS FOT HEATING

MODELS FPR 1200 - FPR 2500 - FPR 3300 - FPR 4950

PICTURE	SUBJECT	PAGE
	<p>Storage, transport, installation procedures, warranty above ground fuel tanks</p>	<p>2/3</p>
	<p>Electric overfill sensor</p>	
	<p>Wireless capacity meter with leak detection (Bundalert)</p>	<p>4/7</p>
	<p style="text-align: center;">!! IMPORTANT !!</p> <p style="text-align: center;">THE FINAL BENOR-CERTIFICATE SHALL ONLY BE GRANTED AFTER RECEPTION OF THE QUESTIONNAIRE. IT NEEDS TO BE FILLED IN COMPLETELY AND SIGNED CORRECTLY.</p>	<p>8/9</p>



INSTALLATION PROCEDURES, MAINTENANCE AND WARRANTY FOR ABOVE GROUND FUEL TANKS

1. STORAGE AND TRANSPORT AND INSTALLATION PROCEDURE

The client acknowledges to have received a copy of this and agrees.

The installation requirements should be read FIRST BEFORE placement.

In the event of loss by the customer of the installation requirements the customer must always ask for a new copy of the installation requirements at Boralit nv, or download them from the Boralit Web site.

Install the tank on a stable, flat and horizontal concrete plate (maximum angle of 1% allowed). Make sure this surface is at least 10 cm longer and wider than the tank itself. Never put tanks on sharp objects such as e.g. gravel. Never install the tank close to a heat source (the tanks are fire class F). Make sure there is a distance of at least 10 cm between the tank and any wall that should be in the proximity of the tank. Always treat the tank carefully. The installation is designed for ambient temperatures of -5 °C and +25 °C, a maximum snow load of 120 kg/m² and wind load of 26 m/s. Take proper measurements if the installation is exposed to other circumstances. Avoid jolts or shocks. The tanks are UV-stabilised so they can be installed outdoors: the tanks are protected to the damaging UV rays (max. 10 years in direct sun rays). If you place your tank under a shelter... the polyethylene will not suffer embrittlement, increasing the life span of your tank.

Prototype standard CP0114/0790-HCC001, CP1012/0690-HCC001 CP0314/0791-HCC001 and CP0716/1073-HCC001.

2. BE CAREFUL

The tanks shouldn't be tested at negative pressure! The test can be done by a pressure test, where the pressure should remain below 0,1 bar for a maximum of 5 minutes. The filling speed shouldn't be above 600l/min. The facility is provided with an electronic overfill sensor. You shouldn't use a whistle. The ventilations shouldn't be smaller than 2" and not higher than 500 mm.

The use of the electrical overfill device is required.

These tanks are made for storage with a flashpoint higher than 55 °C (allowed liquids: diesel fuel, heating oil with maximum 20% petroleum, oils and lubricants with a density lower than 1.000 kg/m³)! Petroleum, gasoline, kerosene, ethanol,... CAN NOT BE STORED IN THE TANKS!

The pump is not a commercial pump. There may be deviations up to 5% occur on the counter. At a full tank not "pumping" with the gun. This can lead to a deviation of more than 20%!!

The bund is tested to withstand 500 hours with liquids. It is therefore of major importance to take measures if this occurs.

3. WARRANTY

We offer a 10-year warranty on all our facilities as far as evident manufacturing faults are concerned. Failure to comply with installation procedure and guidelines voids warranty. All electronic and mechanic parts have a 2-year warranty.

The general sales and warranty conditions of Boralit count.

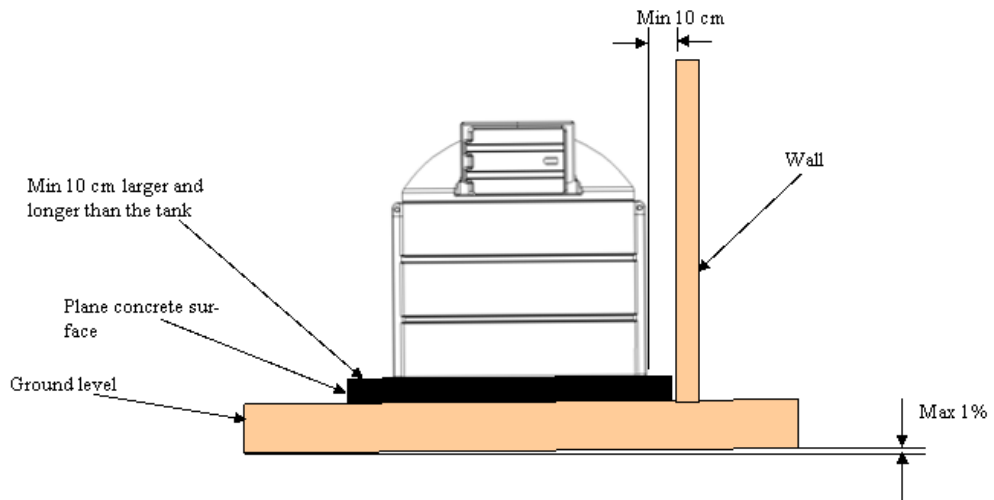

GUIDELINES FOR THE BUNDALERT.

1. **CHARACTERISTICS:**

The Bundalert is a wireless apparatus (radius max. 200m in ideal circumstances) for measuring the volume of a fuel tank.

The Bundalert consists of 2 parts: a measuring unit fixed on the tank (=transmitter) and a unit to be put in a plug-socket which displays the volume (=receiver).

This receiver indicates the volume (percentage – shown by means of bars) of the liquid in the fuel tank. See table at the bottom if you want to know which volume (in liters) corresponds with what number of bars per type of tank.

When the liquid volume in the tank drops under 20%, a little pistol will start to blink on the screen of the receiver and a buzzer will give a sound signal. When the tank is empty, a red lamp will start to blink and a buzzer will give a sound signal.

The Bundalert was already synchronized in our factory. Therefore there can be no interference with a similar system f.i. at your neighbors' place. When putting the receiver unit in the plug-socket, you should wait for max 2 hours before a connection is established and before the volume is indicated on the display. If this is not the case, you should try to synchronize the Bundalart (instructions enclosed) yourself.

At the back side of the receiver there is a dip-switch. Please verify with the table at the bottom. The Bundalert can also be used for other non-inflammable or explosion-free liquids as water, liquid soap,...

The bundalert is also equipped with a leak detection system. A cable with float is fixed on this type of Bundalert. This float has been fixed in the factory between the inner and outer tank. As soon as a liquid flows between the two tanks, all 10 bars and the red lamp will be blinking on the display.

2. **SETTINGS OF THE DIP SWITCH: (has been set, to be checked)**

The dip switch is a little unit with 8 buttons at the backside of the receiver (pict. 1). In setting a specific combination (see table below) the receiver detects the type of tank. You should verify if the correct setting was chosen. You can check by means of the table below the type of tank and the corresponding switches that should be in an upwards position. The other switches should be in a downwards position.

Type of tank	FPR 1200	FPR 2500	FPR 3300	FPR 4950
Position switch	1, 4, 5, 6, 7	1,3,7,8	1, 3, 6, 8	1,2,8



Pict. 1

3. **SYNCHRONISATION: (only when the receiver displays no volume after two hours)**

- 1) Unscrew the green transmitter (fixed on the tank) of the tank. Put the LCD-display in the plug-socket*. A horizontal bar will blink at the top of the screen. This means that the receiver awaits the code of the transmitter (see picture 2).
- 2) Put the spherical little sticker of the transmitter against the little spherical sticker of the display (see picture 3). When the position is OK, bars representing the volume will lighten from 1 to 10. Afterwards they will start to blink. Then pops up a gun and/or dashes. The dashes go up again on the transmitter. Remove the transmitter when the number of dashes appear like in next table.

Type tank	FPR 1200	FPR 2500	FPR 3300	FPR 4950
Aantal streepjes	2	3	3	6

The code has been transmitted

* the receiver waits 2 minutes for a signal of the transmitter. Fix the sender again on the tank.

Install the receiver on the tank.

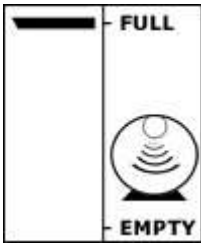

Pict. 2

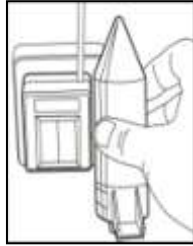

Pict. 3

4. NORMAL DISPLAY-SIGNALS:

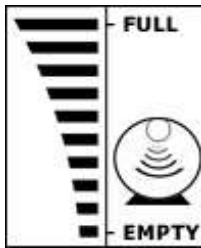

Pict. 4

Tank is full detection

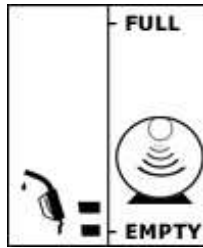

Pict. 5

Less than 20%

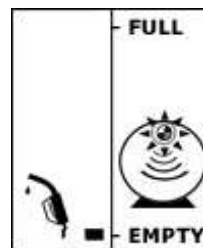

Pict. 6

Less than 10%

5. SPECIAL SIGNALS:

- 1) A triangle, a pistol, a red lamp and all the bars are blinking (picture 7)
 - a) Presence of liquid between the outer and inner tank.
 - b) Pump, when possible the outer tank empty and check whether there is a leakage in the tank.

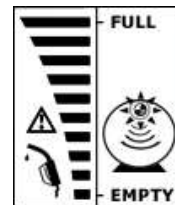

Pict. 7

- 2) A blinking triangle without blinking bar beside (picture 8).
 - a) The receiver is not able to detect a radio signal after 2 hours.
 - b) Synchronize the tankalert again (see above).
 - c) Possibly the distance between receiver and sender is too big.
 - d) The tankalert has been damaged f.i. by moistness,...
 - e) The battery of the sender is empty.

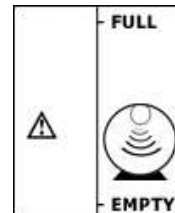

Pict. 8

- 3) A blinking triangle with bar next to it (picture 9).
 - a) Unscrew the sender of the tank (don't tear apart the warranty seal on the sender) and verify if the probe is moisty or has been damaged. If so, the probe should be dried or replaced.
 - b) Verify whether the probe is positioned upright.

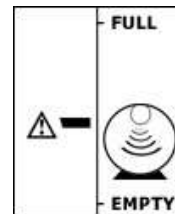

Pict. 9

- 4) An empty display (picture 10).
 - a) The receiver doesn't have any feed.
 - b) The synchronization wasn't proceeded correctly.

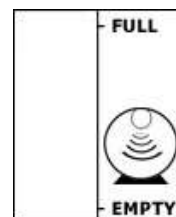

Pict. 10

- 5) The receiver shows one blinking bar before 'Full', but the tank isn't full (picture 11).
 a) The receiver waits for its synchronization.
 b) The receiver was reconnected to the electricity grid.

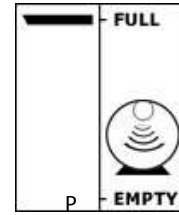

Pict. 11

- 6) The receiver shows the bars before 'Full', however the tank isn't full (picture 12).
 a) The signal signals an obstacle in the tank.
 b) The probe is fixed too tight on the tank.

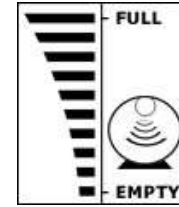

Pict. 12

- 7) The receiver shows the remaining level and a blinking triangle (picture 13).
 a) The battery of the probe is low. Do change the battery (CR2430).

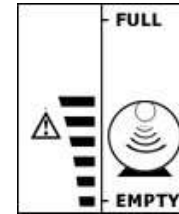

Pict. 13

6) **WARRANTY:**

The tankalart has a warranty of 2 years. ATTENTION: This warranty is only valid when the tankalert has been used in normal conditions and has not been opened (see seal). The battery lasts for five years.

7) **TABLE: INDICATION OF TANKVOLUMES DEDUCED FROM NUMBER OF BARS DISPLAYED**

In the table below you will find the respective volumes corresponding to the number of bars displayed on receiver. The contents are indicative and not binding.

Number of bars	1	2	3	4	5	6	7	8	9	10
FPR 1200	150	250	380	460	635	760	880	1010	1150	1200
FPR 2500	250	500	750	1000	1250	1500	1750	2000	2250	2500
FPR 3300	330	660	990	1320	1650	1980	2310	2640	2970	3300
FPR 4950	580	1150	1720	2300	2860	3420	3880	4380	4750	4950

For instance: you bought a FPR 2500, the receiver displays 5 bars → you still have 1.250 liters in your tank.



8) TABLE WITH POSITION OF THE DIP SWITCH:

In the table below you will find the combinations for the positioning of the dip switches, in case the tankalert/bundalert is used for another type of tank.

Height of the tank (mm)	Following switches switched ON	Height of the tank (mm)	Following switches switched ON
500	All switches OFF	1.750	1,3,4,5,6,7
550	1,7	1.800	1,2,8
600	1,6,8	1.850	1,2,7,8
650	1,6,7,8	1.900	1,2,6,7
700	1,5,7	1.950	1,2,5
750	1,5,6	2.000	1,2,5,7,8
800	1,5,6,7,8	2.050	1,2,5,6,8
850	1,4,8	2.100	1,2,4
900	1,4,6	2.150	1,2,4,7
950	1,4,6,7	2.200	1,2,4,6,8
1.000	1,4,5,8	2.250	1,2,4,6,7,8
1.050	1,4,5,7,8	2.300	1,2,4,5,7
1.100	1,4,5,6,7	2.350	1,2,4,5,6
1.150	1,3	2.400	1,2,4,5,6,7,8
1.200	1,3,7,8	2.450	1,2,3,8
1.250	1,3,6,8	2.500	1,2,3,6
1.300	1,3,5	2.550	1,2,3,6,7
1.350	1,3,5,7	2.600	1,2,3,5,8
1.400	1,3,5,6,8	2.650	1,2,3,5,7,8
1.450	1,3,5,6,7,8	2.700	1,2,3,5,6,7
1.500	1,3,4,7	2.750	1,2,3,4
1.550	1,3,4,6	2.800	1,2,3,4,7,8
1.600	1,3,4,6,7,8	2.850	1,2,3,4,6,8
1.650	1,3,4,5,8	2.900	1,2,3,4,5
1.700	1,3,4,5,6	3.000	1,2,3,4,5,6,8

ATTENTION:

Do not use these devices on tanks with a larger volume than 20.000 liters.

The transmitters can only manage a pressure of 0,3 bar.



QUESTIONNAIRE TO RETRIEVE THE CE-CERTIFICATE FOR ABOVE GROUND FUEL TANKS IN BUND

This specific document has to be filled in carefully and completely by both parties. It needs to be signed and sent back to the following company: **Boralit, Nijverheidslaan 12 - 9880 AALTER or by fax: 09/375.22.22**

THE FINAL BENOR-CERTIFICATE SHALL ONLY BE GRANTED AFTER RECEPTION OF THE QUESTIONNAIRE. IT NEEDS TO BE FILLED IN COMPLETELY AND SIGNED CORRECTLY.

WHEN THE INSTALLATION PROCEDURES ARE NOT FOLLOWED UP PROPERLY, THE WARRANTY IS NO LONGER VALID.

1. DATA FUEL TANK :

Type :

- FPR 1200
- FPR 2500
- FPR 3300
- FPR 4950

Fabrication number (This is mentioned on the metal plate within the pumping unit or manhole):



2. ENDUSER :

Name :

Address :

Telephone :

Mobile phone :

E-mail: :

3. FITTER :

Name :

Company:

Address :

Telephone :

Fax :

Mobile phone :

E-mail :

Confirms that the installation mentioned above has been installed according to the installation procedures that were sent earlier.

Date of installation :

Signature :

4. APPROVED TANK TECHNICIAN :

Name :

Company :

Address :

Telephone :

Fax :

Mobile phone: :

E-mail:

Date check up :

Signature :